

# Lillevilla 497

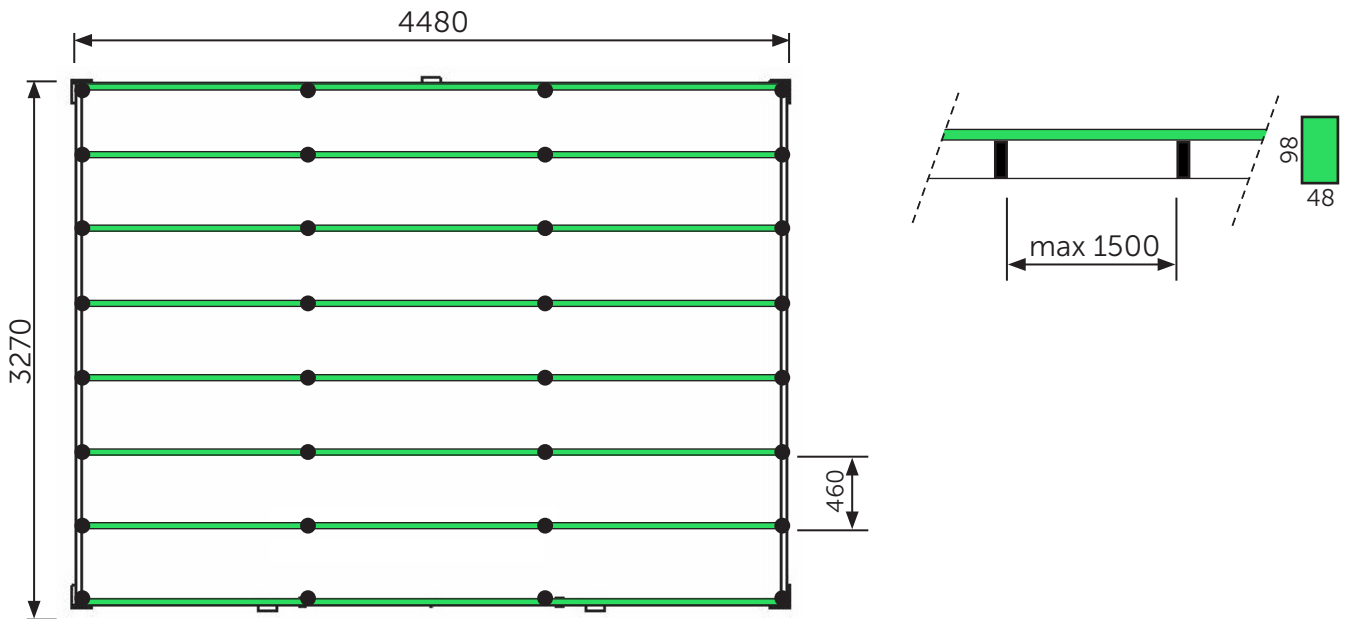

Pilariperustus - Pillar foundation - Pelargrund



Pilariperustus haltiapalkein- Pillar foundation with extra beams- Pelargrund med bärlinor

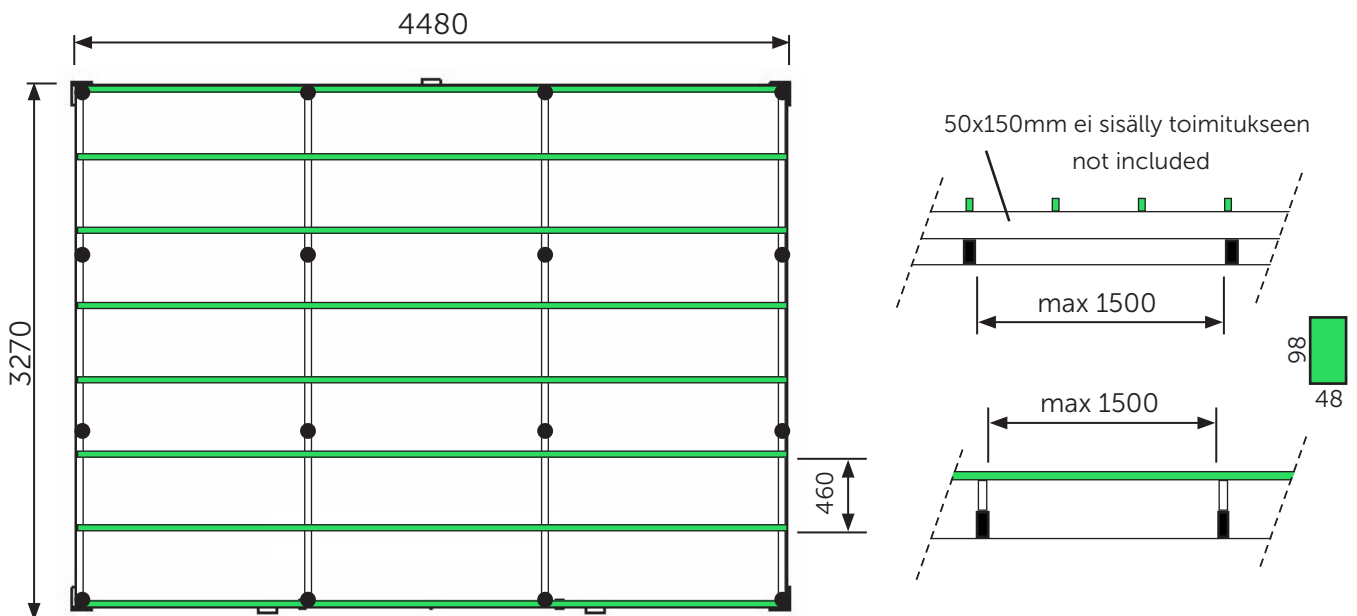

max 150 kg/m<sup>2</sup>



Periaatepiirros haltiapalkkiperustuksesta (palkit eivät sisälly toimitukseen)  
An example of a foundation with extra beams (not included)  
Ett exempel av grund med bärlinor (ingår inte i leveransen)

